



X-45

INSTALLATION AND OPERATION INSTRUCTIONS

L **LOWRANCE ELECTRONICS, INC.**
12000 E. SKELLY DR., TULSA, OK 74128

TABLE OF CONTENTS

INTRODUCTION	3
SPECIFICATIONS	3
INSTALLATION	4
INSTALLATION - Bracket	4
POWER CONNECTIONS	5
KEYBOARD BASICS	6
DISPLAY	6
MENUS	7
OPERATION	7
AUTOMATIC	7
RANGE	8
RANGE - UPPER AND LOWER LIMITS	8
ZOOM	9
SENSITIVITY	11
GRAYLINE®	12
FISH ID	12
TARGETTRACK™	14
CHART SPEED	15
DISPLAY MODE	15
ALARMS	17
LIGHT	18
FEET/METERS	19
DISPLAY CONTRAST	19
ASP (Advanced Signal Processing)	19
SIMULATOR	20
FISH ARCHES	21
WATER TEMPERATURE AND THERMOCLINES	22
TROUBLESHOOTING	23
WARRANTY	27
MISSING PARTS	28

**Copyright © 1995 Lowrance Electronics, Inc.
All rights reserved.**

All features and specifications in this manual are subject
to change without notice.

All screens in this manual are simulated.

INTRODUCTION

Thank you for purchasing a Lowrance sonar. Your X-45 is a high quality sonar designed for both professional and novice fishermen. These units have an automatic feature that finds and displays the bottom, fish, structure, and more! All you have to do is press the on key. However, if you wish to fine tune the unit, simply press the menu key. The X-45 has powerful features available through easy-to-use menus.

Installing an optional speed/temperature sensor lets you view the surface water temperature, boat speed, and distance log. The X-45 also takes advantage of the optional BroadView™ transducer. See page 12 for information on the FishView™ feature that uses this transducer.

SPECIFICATIONS

- Dimensions 5.9" W x 5.35" H x 3.4" D
- Input Voltage 10 - 15 vDC
- Current Drain 350 ma (lights off)
500 ma (lights on)
- Transmitter
 - Frequency 192 kHz
 - Output Power 600 watts (peak-to-peak)
75 watts (RMS)
- Display 100 pixels (H) x 65 pixels (W)
Supertwist Liquid Crystal Display

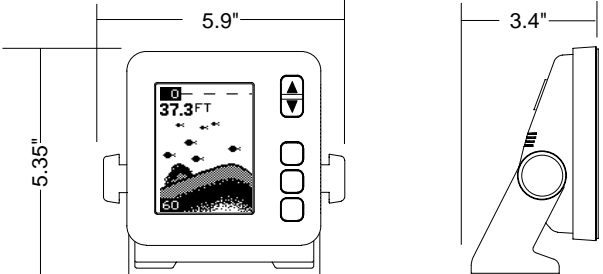

NOTICE!

The storage temperature for your unit is from -4 degrees to +167 degrees Fahrenheit (-20 degrees to +75 degrees Celcius). Extended storage in temperatures higher or lower than specified will damage the liquid crystal display in your unit. This type of damage is not covered by the warranty. For more information, contact the factory customer service department or your local service center.

INSTALLATION - Bracket

You can install the X-45 on the top of a dash or from an overhead with the supplied bracket. It can also be installed in the dash with an optional IDA-3 or IDA-4 mounting kit. If you use the supplied bracket, you may be interested in the optional GBSA-1 swivel bracket kit. This converts the X-45's gimbal bracket to a swivel mount which can be used on the dash or overhead mounting positions. Installation instructions for the in-dash and swivel mounting kits are supplied with the adapter kits.

Mount the X-45 in any convenient location, provided there is clearance when it's tilted for the best viewing angle. Holes in the bracket's base allow wood screw or through bolt mounting. It may be necessary to place a piece of plywood on the back side of thin panels to reinforce the panel. Make certain there is enough room behind the unit to attach the power and transducer cables.

Drill a hole in the dash for the power and transducer cables. The best location for this hole is immediately under the gimbal bracket. This way, the bracket covers the hole. The smallest hole the power or transducer cable connector can pass through is 3/4". However, you can't pass a power or transducer connector and another cable through a 3/4" hole. Therefore, after drilling the hole, pass the transducer connector up through the hole from under the dash. Then drop the power cable down from the front side of the dash. After installing the transducer and power cables, slide the bracket over the hole, then route the transducer and power cables out the slot in the back of the bracket. Finally, fasten the bracket to the dash.

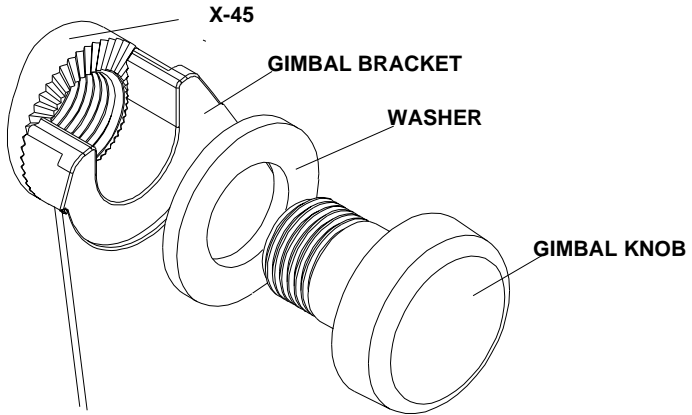

Attach the X-45 to the gimbal bracket using the supplied gimbal knobs and washers as shown above.

POWER CONNECTIONS

The X-45 works from a 12 volt DC system only. For the best results, run the power cable directly to the boat's battery. Keep the power cable away from other boat wiring, especially the engine's wires. This will give the best isolation from electrical noise. If the supplied cable is not long enough to reach the battery, splice #18 gauge insulated wire to it. If you do extend the power cable, make certain to attach the in-line fuse holder supplied with the X-45 to the battery or power source. This will protect both the unit and the power cable in the event of a short. Use only a 3-amp fuse.

IMPORTANT!

Do not use this product without a 3-amp fuse wired into the power cable! Failure to use a 3-amp fuse will void your warranty!

You can also attach the power cable to an accessory or power buss, however, you may have problems with electrical interference.

This units has reverse polarity protection. No damage will occur if the power wires are reversed. However, the unit will not work until the wires are attached correctly.

If you've purchased a speed/temperature sensor, install it according to the instructions enclosed with it. Route its cable to the connector on the X-45's power cable. The X-45 is now ready for use.

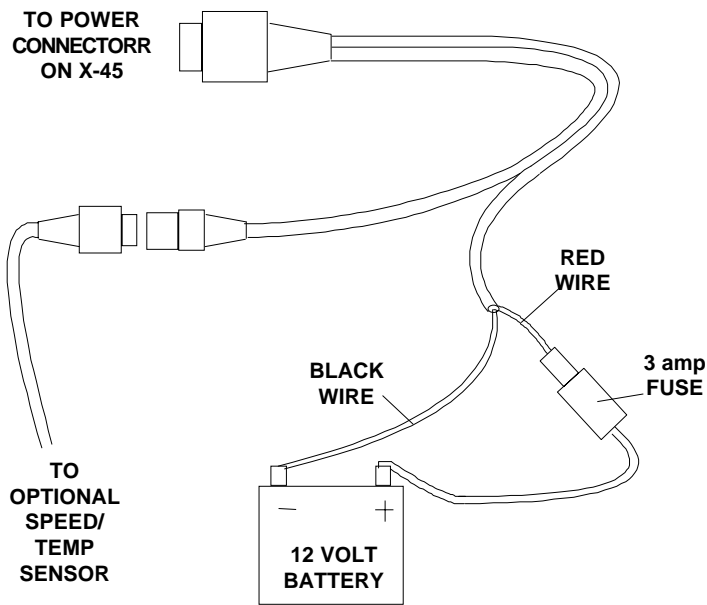

KEYBOARD BASICS

The unit sounds a tone when you press any key. This tells you the unit has accepted a command.

ON/CLEAR

Use this key to turn the unit on. It also clears menu selections and the menus from the screen.

OFF

This key turns the unit off.

MENU

The X-45 has many features that are accessed with this key. To see the first menu, press the MENU key. To see the other menus, press the MENU key repeatedly.

UP and DOWN ARROWS

Use these keys to adjust virtually every feature and function on the unit.

NOTE: The up arrow key also stops the chart when no menus are displayed. In other words, anytime you wish to stop the chart, first make certain no menu is on the screen. Now press the up arrow key. The chart freezes and the word "STOP" appears at the top of the screen. To start the chart, press the up arrow key again.

DISPLAY - General

The lights flash for about ten seconds when the X-45 is turned on. Three menus appear, one after the other. The menus are the lights (LAMP), feet-meter selection (FEET/METER), and contrast adjustment (DARK/LIGHT). To turn the lights on, press the up arrow key. To switch from feet to meters, press the down arrow key when the proper menu appears. To adjust the contrast, wait for the DARK/LIGHT menu to appear. Now press the up arrow key to darken the screen, the down arrow to lighten it. The menus disappear after a few seconds. If you don't want to wait, press the ON/CLEAR key to clear the menus from the screen.

When the X-45 is first turned on, the display appears similar to the one at right. The unit is in the automatic mode. The depth range displays on the upper left side of the screen.

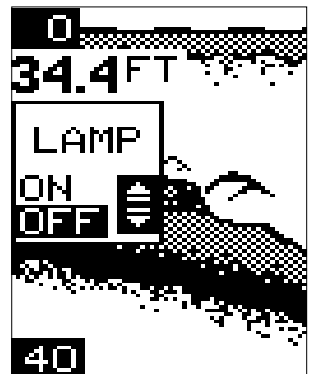

In the example shown at the bottom of the previous page, the range is from 0 to 60 feet and the bottom depth is 37.3 feet.

NOTE: Turning the X-45 off erases all user settings and it returns to the system defaults. For example, if you turn the lights on, then turn the unit off, the next time you turn the unit on, the lights will be off, since the default setting for the lights is off.

MENUS

The X-45 uses menus to guide you through the unit's functions and features. The menu key accesses these features, allowing you to customize the unit to your particular needs and water conditions. All you have to do to leave one menu and enter another is press the menu key repeatedly. If you ever get lost in the menus, simply press the ON/CLEAR key. This clears the menus from the screen.

Menus change depending on the mode the unit is in. For example, if the automatic mode is turned off, the sensitivity menu changes from "AUTO SENS" to "MAN SENS." Other messages may appear in menu boxes or new menus can appear, again depending on previous selections.

On the screen shown on the previous page, the lamp menu is showing. Pressing the up arrow key while this menu is on the screen turns the back lights on.

OPERATION

AUTOMATIC

When the X-45 is first turned on, the automatic feature is enabled. This feature automatically adjusts the unit's range and sensitivity according to water conditions. It always keeps the bottom depth displayed in the lower portion of the screen.

To turn the automatic feature off, press the menu key until the AUTO/MAN menu appears. Now press the down arrow key. This highlights the letters "MAN." The unit is now in the manual mode. Wait a few seconds and the menu will scroll off the screen's left side. Pressing the ON/CLEAR key also clears it. To turn the automatic feature on again, repeat the above steps, except this time press the up arrow key.



RANGE

You can't adjust the range when the X-45 is in the automatic mode. It is adjustable when the unit is in the manual mode, however. To do so, first put the unit in the manual mode. Now press the ON/CLEAR key to clear the screen. Then press the menu key until the "RANGE SEL" menu appears as shown below. The current range shows at the bottom of the menu. In this case, the range is 60 feet. Now press the up arrow key to decrease the range, the down arrow key increases the range. After you select the desired range, press the ON/CLEAR key to clear the display. If you wait a few seconds, it automatically clears.

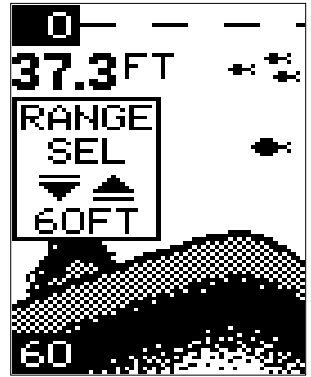

The X-45 has the following ranges:

10, 20, 40, 60, 120, 240, 480, and 900 feet.

and

5, 10, 20, 40, 60, 100, 200, and 300 meters.

NOTE: The depth capability of the X-45 depends on the transducer installation, water and bottom conditions, and other factors.

RANGE - Upper and Lower Limits

The X-45 lets you change the upper and lower range limits when it's in the manual mode. This lets you "zoom" in on segments of the water as small as 10 feet. In other words, you can set the upper limit to 25 feet and the lower limit to 35 feet, regardless of the bottom depth. This in essence, gives you a 10 foot zoom. You can choose any segment of the water, as long as the distance between the upper limit and lower limit is 10 feet (10 meters) or more.

To change the upper limit, first make certain the unit is in the manual mode. Next, press the MENU key until the "UPPER LIMIT" menu appears. Now press the down arrow key to increase the upper limit or the up arrow key to increase it. After you've finished, wait a few

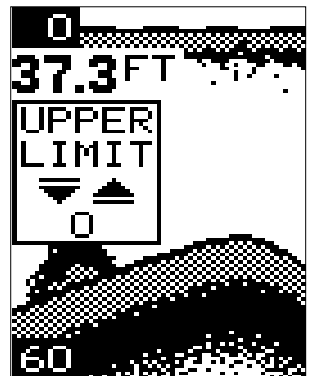

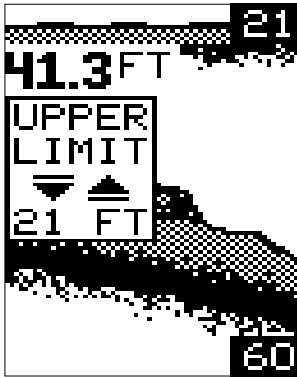

21 FOOT UPPER LIMIT



seconds and the menu will scroll off the screen's left side. Pressing the ON/CLR key also clears it.

To change the lower limit, again make certain the unit is in the manual mode. Press the MENU key until the "LOWER LIMIT" menu appears. Now press the down arrow key to increase the lower limit or the up arrow key to increase it. When you have the limit set, wait a few seconds and the menu will scroll off the screen's left side. Pressing the ON/CLR key also clears it.

ZOOM

The zoom feature enlarges all echoes on the screen. If the unit is in the automatic mode, it tracks the bottom signal, always keeping it near the bottom of the screen. This lets you see small detail, at the same time enlarging all echoes that appear on the screen. The unit doesn't track the bottom in the manual mode, and the adjustments are slightly different.

Zoom - Automatic Operation

To zoom the display, first press the MENU key until the RANGE/ZOOM menu appears as shown at right. Now press the down arrow key. This switches the unit into the zoom mode. A new menu immediately appears as shown at the top of the next page.

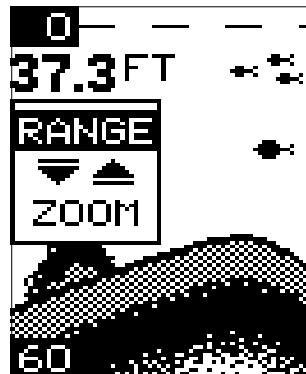

This is the zoom size menu. Zoom size is the distance between the upper limit and the lower limit. The upper limit shows at the top left corner of the screen. The lower limit is in the bottom left corner. For example, if the upper limit is 40 feet and the lower limit is 70 feet, the zoom window size is 30 feet. The word "TRACK" appears in this menu when you first activate the zoom as shown below. This means the X-45 is tracking the bottom in a zoom window, always keeping it on the display.



Press the up arrow key to decrease the zoom size, press the down arrow key to increase the zoom size.

When the unit is switched into the zoom mode, the letters "ZM" appear at the top of the screen. The zoom window size displays in the top right corner of the screen.

On the screen shown at right, the zoom size has been changed to 20 feet.

To turn the zoom feature off, press the menu key until the RANGE/ZOOM menu appears. Now press the up arrow key.

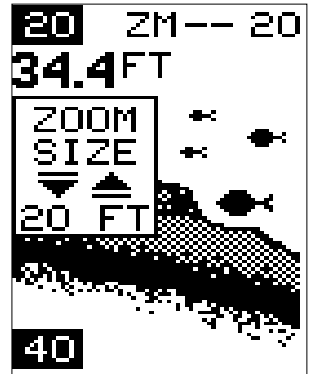

This switches the unit into the range mode, which turns the zoom feature off.

The X-45 has the following zoom ranges:

- 10, 20, 30, 60, 120, 240, and 480 feet
- and
- 5, 10, 20, 30, 50, 100, and 150 meters.

Zoom - Manual Operation

To operate the zoom feature when the X-45 is in the manual mode, first press the menu key. Then press the down arrow key in the RANGE/ZOOM menu to place the X-45 in the zoom mode. The zoom size menu automatically appears next. You can change the zoom size by pressing the up or down arrows. After you select the desired zoom size, press the

menu key until the “MOVE ZOOM” menu appears. This menu lets you move the zoom window up or down in *one foot* increments by pressing the arrow keys. Thus, you can move the zoom window up towards the surface, down to the bottom, or anywhere in between. The window stays where you put it. It doesn’t track the bottom signal.

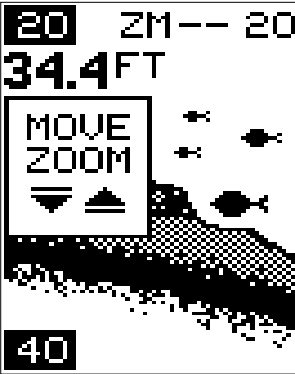

To turn the zoom feature off, press the menu key until the RANGE/ZOOM menu appears. Now press the up arrow key. This switches the unit into the range mode, which turns the zoom feature off.

SENSITIVITY

The sensitivity menu lets you control the unit’s ability to pick up echoes. A low sensitivity level excludes much of the bottom information, fish signals, and other detail. High sensitivity settings lets you see features, but it can also clutter the screen with noise and other unwanted signals. Typically, the best sensitivity level shows a good, solid bottom signal with grayline.

The X-45 adjusts the sensitivity level to keep a solid bottom signal on the screen. It adds a little extra when it’s in the automatic mode. This gives it the capability to show fish and other detail. However, situations occur where it becomes necessary to increase or decrease the sensitivity level. Typically, this occurs when you wish to see more detail, so you need to increase the sensitivity. The procedure to adjust it is the same whether the unit is in the automatic or manual mode.

To change the sensitivity level, first press the menu key until the sensitivity menu appears. If the unit is in automatic, the menu shows “AUTO SENS.” Otherwise, the menu shows “MAN SENS.” Now press the up arrow key to increase the sensitivity, the down arrow to decrease it. A vertical bar graph in the menu box shows the sensitivity level. Echoes scrolling onto the screen will also show the effects of the sensitivity change. If you reach the maximum or minimum sensitivity level, a tone sounds alerting you to the limits.

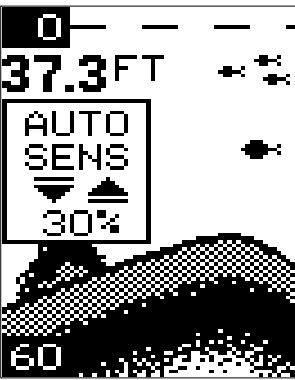

After you’ve adjusted the unit to the desired sensitivity level, press the ON/

CLEAR key to clear the display. If you wait a few seconds, it will automatically clear.

GRAYLINE®

Grayline lets you distinguish between strong and weak echoes. It “paints” gray on targets that are stronger than a preset level. This shows the difference between a hard or soft bottom, large fish versus smaller ones, or rocks and brush on the bottom. For example, a soft, muddy, or weedy bottom returns a weaker signal which shows a narrow or no gray line. A hard bottom returns a strong signal that causes a wide gray line.

If you have two targets of equal size, one with gray and the other without, the target with gray is the stronger echo. This helps distinguish fish from structure, or the larger fish from a smaller one.

Grayline® is adjustable. Since it shows the difference between strong and weak echoes, changing the level may require a different sensitivity setting.

To change the Grayline level, first press the MENU key until the Grayline menu appears. Now press the up arrow key to increase the level, the down arrow to decrease it. The bar graph in the Grayline menu box shows the level of Grayline now in use. Echoes scrolling onto the screen will also show the effects of the Grayline change. If you reach the maximum or minimum level, a tone sounds alerting you to the limits.

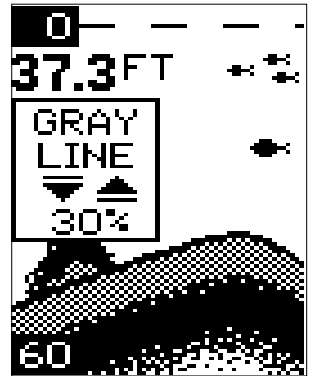

The level chosen by the X-45 when it's first turned on is usually adequate for most conditions. Experiment with your unit to find the Grayline setting that's best.

FISH ID FEATURE

The Fish ID feature identifies targets that meet certain conditions as fish. The microcomputer analyses all echoes and eliminates surface clutter, thermoclines, and other undesirable signals. In most instances, remaining targets are fish. The Fish ID feature displays symbols on the screen in place of the actual fish echoes. There are four symbol sizes: tiny, small, medium, and large. These show the relative size between targets. In other

words, it displays a small fish symbol when it thinks a target is a small fish, a medium fish symbol on a larger target, etc.

The microcomputer is sophisticated, but it can be fooled. It can't distinguish between fish and other suspended objects such as turtles, submerged floats, air bubbles, etc. Individual tree limbs extending outwards from a group of limbs are the hardest objects for the Fish ID feature to distinguish from fish. You may see Fish ID symbols on the screen when, in fact, there are no fish. Practice with the unit when the Fish ID feature is on and off to become more familiar with Fish ID. To turn this feature on, press the menu key until the Fish ID feature's menu appears as shown at right. Now press the up arrow key. This turns the feature on. To turn it off, repeat the above steps, but press the down arrow key instead.



The Fish ID feature can't be used when the X-45 is in the manual mode. If you turn the automatic feature off, the Fish ID feature will automatically be turned off, also.

TargetTrack™

The X-45 has the unique capability to "see" targets not only straight down, but also to the right and left, thanks to the optional BroadView™ transducer (not included). This transducer has three elements: left, right, and down. The X-45 uses all three elements to display targets between the surface and the bottom. Targets are shown as Fish ID symbols. This feature also shows the depth of the target directly above the fish symbol. In the screen shown below right, there is one symbol from the right element at 22 feet, one from the left element at 29 feet, and one from the center element at 16 feet. The TargetTrack feature identifies fish symbols coming from the right element with a "R" in front of the symbol's depth. A "L" identifies symbols from the left element. No letter identifies fish symbols from the center element. The bottom signal and the digital depth display are read from the center element only.

To turn the TargetTrack feature off, simply press the MENU key until its menu appears as shown below, then press the down arrow key.



CHART SPEED

The rate echoes scroll across the screen is called the chart speed. It's adjustable by pressing the menu key until the chart speed menu appears. Chart speed is set to maximum when the X-45 is first turned on. To decrease it, press the down arrow key. Press the up arrow key to increase the speed again. The bar graph in the Chart Speed menu box shows a graph of the speed. Echoes scrolling onto the screen will also show the effects of the change. If you reach the maximum or minimum level, an warning tone sounds.

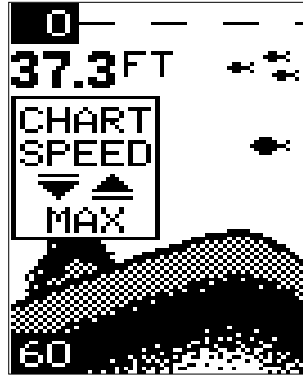

To stop the chart, first clear any menu from the screen by pressing the ON/CLEAR key. You can't stop the chart while a menu is displayed. Now press the up arrow key. The chart will freeze and the word "STOP" appears at the top right portion of the screen. To start the chart, press the up arrow key again.

DISPLAY MODE

The X-45 has three different screen modes. To change modes, press the MENU key until the "DISP MODE" (Display Mode) menu appears. Then press the up or down arrow keys until the desired mode number appears. The modes are as follows:

CHT 1 (Chart #1)

This is the default mode used when the X-45 is first turned on. It has the following features:

1. Automatic On
2. Fish ID Feature Off
3. Digital Depth Display On

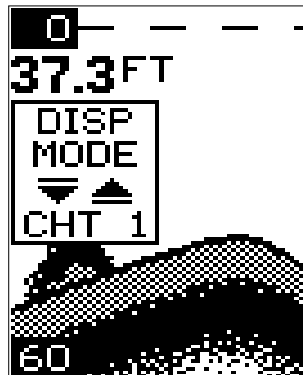

CHT 2 (Chart #2)

Same as Chart #1 plus digital surface water temperature display.



CHT 3 (Chart #3)

Same as Chart #1 plus a digital speed display.



CHT 4 (Chart #4)

This is the High Speed Scroll mode. It has the following features:

1. Automatic Off
2. Fish ID Feature Off
3. All Digital Displays Off

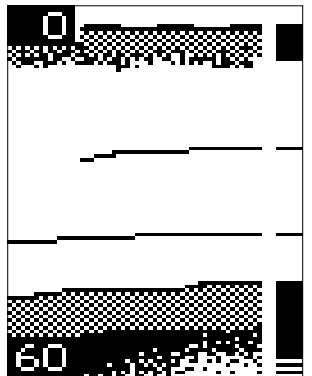

DIG 1 (Digital #1)

This is the first digital only screen. It shows the digital depth display at the top of the screen in very large numbers. The shallow and deep alarm settings are displayed beneath the digital depth. No chart shows on this screen.

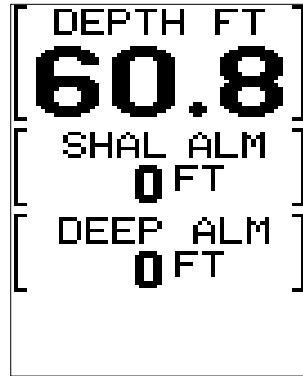

DIG 2 (Digital #2)

The digital depth display shows at the top of this screen in very large digits. The digital temperature, speed, and log shows beneath the depth. The log starts counting when the X-45 is first turned on. When the X-45 is turned off, the log is reset to zero.

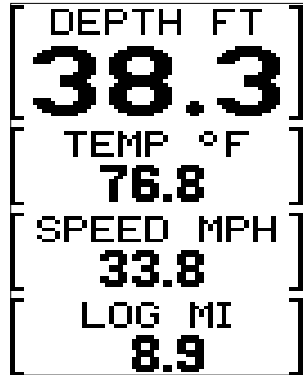

ALARMS

FISH ALARM

The Fish Alarm sounds a tone when a fish symbol appears on the screen. To use the fish alarm, press the menu key until the "FISH ALARM" menu appears on the screen. Now press the up arrow key to turn the alarm on. Repeat the above steps to turn the fish alarm off. (Note: If the Fish ID feature is off, it will be turned on when you turn the fish alarm on.)

DEPTH ALARMS

The depth alarms are triggered only by the bottom signal. No other echoes will activate these alarms. The depth alarms consist of a shallow and deep alarm. The shallow alarm sounds an alarm tone when the bottom goes



shallower than the alarm's setting. The deep alarm sounds a tone when the bottom goes deeper than it's setting. Both alarms adjust the same, although through different menus.

Shallow Alarm

To set the shallow alarm, press the menu key repeatedly until the "SHAL ALARM" menu appears. Press the down arrow key to increase the shallow alarm's depth setting, the up arrow key decreases it. The number in the shallow alarm's menu box shows the current shallow alarm setting. When the number reaches the desired setting, release the arrow key. When the bottom depth goes shallower than the alarm's setting an alarm tone sounds. At the same time the alarm sounds, a message box appears on the screen as shown at right.

Press the up arrow key to silence the alarm. This will turn the alarm sound off until the shallow alarm is triggered again.

To turn the alarm off, press the menu key until the shallow alarm menu appears. Then press the up arrow key until the word "OFF" appears.

Deep Alarm

The deep alarm adjusts the same as the shallow alarm. Use the "DEEP ALARM" menu to adjust the deep alarm. When the bottom signal goes deeper than the setting, an alarm tone sounds.

LIGHTS

The X-45's display is backlit for night use. To turn the backlights on or off, press the menu key repeatedly until the LAMP menu appears. Now press the up arrow to turn the lights on or the down arrow to turn them off. The menu will clear automatically after a few seconds.

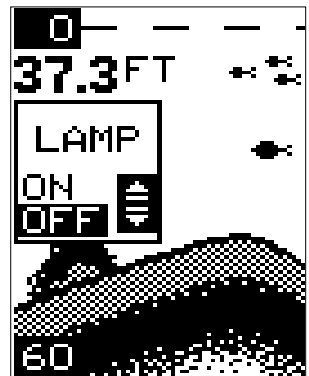

FEET/METER

The X-45 can show the depth in feet or meters, temperature in degrees Fahrenheit or Celsius, speed in statute miles per hour or knots, and distance (log) in statute miles or nautical miles. When the unit is in the metric mode, all depth readings, ranges, zooms, and alarm settings are in meters. When a unit is in the feet mode, all of the above settings are in feet.

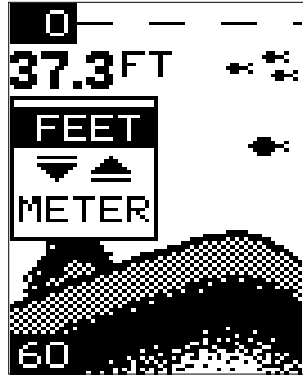

To change from feet to meters or vice-versa, press the menu key until the FEET/METER menu appears as shown at the bottom of the previous page. Press the down arrow key to switch to metric, the up arrow to switch to feet. Displays show in feet when the unit is first turned on. The menu will clear automatically after a few seconds or you can press the ON/CLEAR key to clear the screen.

DISPLAY CONTRAST

The unit's display contrast is adjustable to suit different lighting conditions. This will help you see the screen from different angles, or at various times of the day.



To adjust the contrast, press the menu key until the DARK/LIGHT menu appears. To decrease it, press the down arrow key. Press the up arrow key to increase the contrast. The bar graph in the Dark/Light menu box shows a graph of the contrast. The screen will also show the effects of the change. If you reach the maximum or minimum level, a tone sounds alerting you to the limits. The menu will clear automatically after a few seconds or you can press the ON/CLEAR key to clear the screen.

ASP (Advanced Signal Processing)

ASP is a program embedded in the X-45's computer that is specifically designed to eliminate noise. It continually monitors the signals from the receiver, determines which echoes are noise and rejects them. This allows true target echoes to display on the screen with a minimum of clutter. This feature is especially useful since it typically lets you operate the boat at all

speeds without adjusting the sensitivity or other controls. When the X-45 is first turned on, ASP is enabled. To turn ASP off, press the menu key repeatedly until the ASP menu appears. Now press the up arrow to turn it on or the down arrow to turn it off. The menu will clear automatically after a few seconds or you can press the ON/CLEAR key to clear the screen.

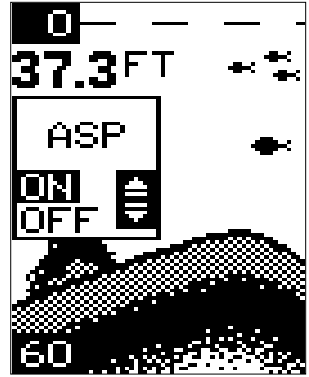

SIMULATOR

The X-45 has a simulator built into it that can show a simulated bottom signal with fish. All features of the X-45 work normally when the simulator is in use. You can change the range, zoom, and use the alarms as desired. To use the simulator, press the menu key repeatedly until the SONAR SIM menu appears. Now press the up arrow to turn it on. Repeat the above steps to turn it off, or turn the unit off and back on again.

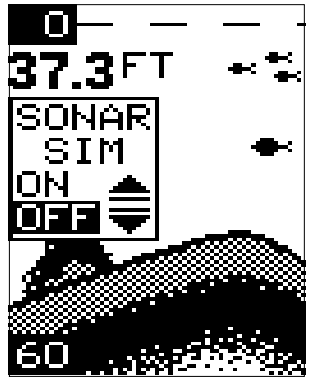

FISH ARCHES

Fish arches are created when the cone of sound passes over a fish. The distance to a fish when the cone first strikes it is shown as "A" below. When the center of the cone strikes the fish, the distance is shorter as shown "B". As the cone leaves the fish, the distance increases again as shown in "C".

When the Fish I.D. mode is off, the depth of the water will affect the size and shape of the fish arch due to the cone angle diameter. For example, if the cone passes over a fish in shallow water, the signal displayed on the X-45 may not arch at all. This is due to the narrow cone diameter and the resolution limitations of the display.

Very small fish probably will not arch at all. Medium sized fish will show a partial arch, or a shape similar to an arch if they're in deep water.

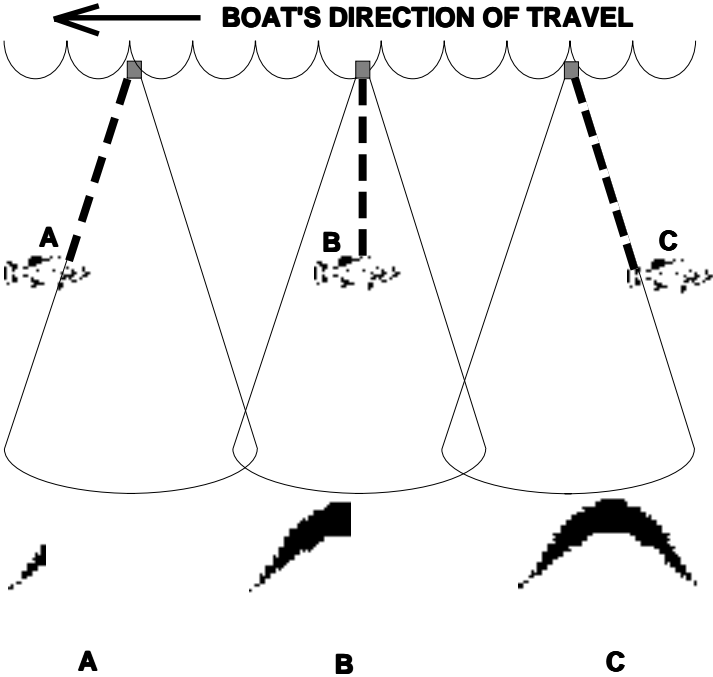

Large fish will arch, but turn the sensitivity up in deeper water to see the arch. Because of water conditions, such as heavy surface clutter, thermoclines, etc., the sensitivity sometimes cannot be increased enough to get fish arches.

One of the best ways to get fish arches is to expand or “zoom” a segment of the water. For example, from 45 to 60 feet. The smaller the segment, the better the screen resolution will be. The easiest way to do this on the X-45 is with the Zoom feature. This feature expands the echoes, making it easier to see detail. For the best results, turn the sensitivity up as high as possible without getting too much noise on the screen. In medium to deep water, this method should work to display fish arches.

If you see fish signals when the unit is in the manual mode, but don't get fish symbols when Fish I.D. is on, try increasing the sensitivity.

WATER TEMPERATURE AND THERMOCLINES

Water temperature has an important-if not controlling-influence upon the activities of all fish. Fish are cold blooded and their bodies are always the temperature of the surrounding water. During the winter, colder water slows down their metabolism. At this time, they need about a fourth as much food as they consume in the summer.

Most fish don't spawn unless the water temperature is within rather narrow limits. The surface temperature meter built into the X-45 helps identify the desired surface water spawning temperatures for various species. Trout can't survive in streams that get too warm. Bass and other fish eventually die out when stocked in lakes that remain too cold during the summer. While some fish have a wider temperature tolerance than others, each has a certain range within which it tries to stay. Schooling fish suspended over deep water lie at the level that provides this temperature. We assume they are the most comfortable here.

The temperature of water in the lake is seldom constant from top to bottom. Layers of different temperatures form, and the junction of a warm and cool layer of water is called a thermocline. The depth and thickness of the thermocline can vary with the season or time of day. In deep lakes there may be two or more at different depths. Thermoclines are important to fishermen because they are areas where fish are active. Many times bait fish will be above the thermocline while larger game fish will suspend in or just below it.

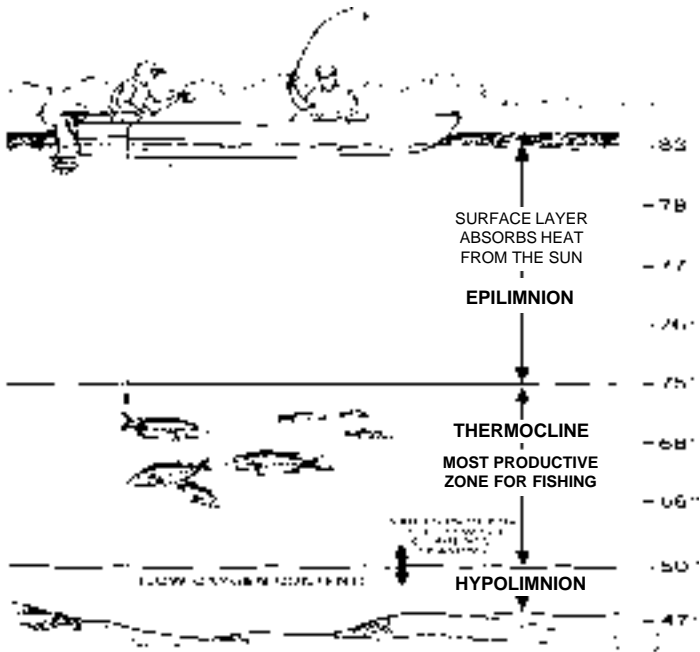

The X-45 can detect this invisible layer in the water, but Fish ID will have to be off and the sensitivity will probably have to be turned up to see it.

TROUBLESHOOTING

If your unit is not working, or if you need technical help, please use the following troubleshooting section before contacting the factory customer service department. It may save you the trouble of returning your unit.

Unit won't turn on:

1. Check the power cable's connection at the unit. Also check the wiring.
2. Make certain the power cable is wired properly. The red wire connects to the positive battery terminal, black to negative or ground.
3. Check the fuse.
4. Measure the battery voltage at the unit's power connector. It should be at least 11 volts. If it isn't, the wiring to the unit is defective, the battery terminals or wiring on the terminals are corroded, or the battery needs charging.

Unit freezes, locks up, or operates erratically:

1. Electrical noise from the boat's motor, trolling motor, or an accessory may be interfering with the sonar unit. Rerouting the power and transducer cables away from other electrical wiring on the boat may help. Route the sonar unit's power cable directly to the battery instead of through a fuse block or ignition switch
2. Inspect the transducer cable for breaks, cuts, or pinched wires.
3. Check the transducer and power connector. Make certain it's securely plugged in to the unit.

Weak bottom echo, digital readings erratic, or no fish signals:

1. Make certain transducer is pointing straight down. Clean the face of the transducer. Oil, dirt, and fuel can cause a film to form on the transducer, reducing its effectiveness. If the transducer is mounted inside the hull, be sure it is shooting through only one layer of fiberglass and that it is securely bonded to the hull. Do NOT use RTV silicone rubber adhesive or Marinetex™.
2. Electrical noise from the boat's motor can interfere with the sonar. This causes the sonar to automatically increase its Discrimination or noise rejection feature. This can cause the unit to eliminate weaker signals such as fish or even structure from the display.
3. The water may be deeper than the sonar's ability to find the bottom. If the sonar can't find the bottom signal while it's in the automatic mode, the digital will flash continuously. It may change the range to limits far greater than the water you are in. If this happens, place the unit in the manual mode, then change the range to a realistic one, (for example, 0-100 feet) and increase the sensitivity. As you move into shallower water, a bottom signal should appear.
4. Check the battery voltage. If the voltage drops, the unit's transmitter power also drops, reducing its ability to find the bottom or targets.

Bottom echo disappears at high speeds or erratic digital reading or weak bottom echo while boat is moving

1. The transducer may be in turbulent water. It must be mounted in a smooth flow of water in order for the sonar to work at all boat speeds. Air bubbles in the water disrupt the sonar signals, interfering with its ability to find the bottom or other targets. The technical term for this is 'Cavitation'.
2. Electrical noise from the boat's motor can interfere with the sonar. This

causes the sonar to automatically increase its Discrimination or noise rejection feature. This can cause the unit to eliminate weaker signals such as fish or even structure from the display. Try using resistor spark plugs or routing the sonar unit's power and transducer cables away from other electrical wiring on the boat.

No fish arches when the Fish ID feature is off:

1. Make certain transducer is pointing straight down. This is the most common problem if a partial arch is displayed. See the Fish Arch section in your owner's manual for more information.

2. The sensitivity may not be high enough. In order for the unit to display a fish arch, it has to be able to receive the fish's echo from the time it enters the cone until it leaves. If the sensitivity is not high enough, the unit displays the fish only when it is in the center of the cone.

3. Use the Zoom feature. It is much easier to display fish arches when zoomed in on a small range of water than a large one. For example, you will have much better luck seeing fish arches with a 30 to 60 foot range than a 0 to 60 foot range. This enlarges the targets, allowing the display to show much more detail.

4. The boat must be moving at a slow trolling speed to see fish arches. If the boat is motionless, fish stay in the cone, showing on the display as straight horizontal lines.

ELECTRICAL NOISE

A major cause of sonar problems is electrical noise. This usually appears on the sonar's display as random patterns of dots or lines. In severe cases, it can completely cover the screen with black dots, or cause the unit operate erratically, or not at all.

To eliminate or minimize the effects of electrical noise, first try to determine the cause. With the boat at rest in the water, the first thing you should do is turn all electrical equipment on the boat off. Make certain the engine is off, also. Turn your X-45 on, then turn off ASP (Advanced Signal Processing). There should be a steady bottom signal on the display. Now turn on each piece of electrical equipment on the boat and view the effect on the sonar's display. For example, turn on the bilge pump and view the sonar display for noise. If no noise is present, turn the pump off, then turn on the VHF radio and transmit. Keep doing this until all electrical equipment has been turned on, their effect on the sonar display noted, then turned off.

If you find noise interference from an electrical instrument, trolling motor,

pump, or radio, try to isolate the problem. You can usually reroute the sonar unit's power cable and transducer cable away from the wiring that is causing the interference. VHF radio antenna cables radiate noise when transmitting, so be certain to keep the sonar's wires away from it. You may need to route the sonar unit's power cable directly to the battery to isolate it from other wiring on the boat.

If no noise displays on the sonar unit from electrical equipment, then make certain everything except the sonar unit is turned off, then start the engine. Increase the RPM with the gearshift in neutral. If noise appears on the display, the problem could be one of three things; spark plugs, alternator, or tachometer wiring. Try using resistor spark plugs, alternator filters, or routing the sonar unit's power cable away from engine wiring. Again, routing the power cable directly to the battery helps eliminate noise problems. **Make certain to use the in-line fuse supplied with the unit when wiring the power cable to the battery!**

When no noise appears on the sonar unit after all of the above tests, then the noise source is probably cavitation. Many novices or persons with limited experience make hasty sonar installations which function perfectly in shallow water, or when the boat is at rest. In nearly all cases, the cause of the malfunction will be the location and/or angle of the transducer. The face of the transducer must be placed in a location that has a smooth flow of water at all boat speeds. Read your transducer owner's manual for the best mounting position.

LOWRANCE ELECTRONICS FULL ONE-YEAR WARRANTY

"We", "our", or "us" refers to LOWRANCE ELECTRONICS, INC., the manufacturer of this product. "You" or "your" refers to the first person who purchases this product as a consumer item for personal, family, or household use.

We warrant this product against defects or malfunctions in materials and workmanship, and against failure to conform to this product's written specifications, all for one year (1) from the date of original purchase by you. WE MAKE NO OTHER EXPRESS WARRANTY OR REPRESENTATION OF ANY KIND WHATSOEVER CONCERNING THIS PRODUCT. Your remedies under this warranty will be available so long as you can show in a reasonable manner that any defect or malfunction in materials or workmanship, or any non-conformity with the product's written specifications, occurred within one year from the date of your original purchase, which must be substantiated by a dated sales receipt or sales slip. Any such defect, malfunction, or non-conformity which occurs within one year from your original purchase date will either be repaired without charge or be replaced with a new product identical or reasonably equivalent to this product, at our option, within a reasonable time after our receipt of the product. If such defect, malfunction, or non-conformity remains after a reasonable number of attempts to repair by us, you may elect to obtain without charge a replacement of the product or a refund for the product. THIS REPAIR, REPLACEMENT, OR REFUND (AS JUST DESCRIBED) IS THE EXCLUSIVE REMEDY AVAILABLE TO YOU AGAINST US FOR ANY DEFECT, MALFUNCTION, OR NON-CONFORMITY CONCERNING THE PRODUCT OR FOR ANY LOSS OR DAMAGE RESULTING FROM ANY OTHER CAUSE WHATSOEVER. WE WILL NOT UNDER ANY CIRCUMSTANCES BE LIABLE TO ANYONE FOR ANY SPECIAL, CONSEQUENTIAL, INCIDENTAL, OR OTHER INDIRECT DAMAGE OF ANY KIND.

Some states do not allow the exclusion or limitation of incidental or consequential damages, so the above limitations or exclusions may not apply to you.

This warranty does NOT apply in the following circumstances: (1) when the product has been serviced or repaired by anyone other than us, (2) when the product has been connected, installed, combined, altered, adjusted, or handled in a manner other than according to the instructions furnished with the product, (3) when any serial number has been effaced, altered, or removed, or (4) when any defect, problem, loss, or damage has resulted from any accident, misuse, negligence, or carelessness, or from any failure to provide reasonable and necessary maintenance in accordance with the instructions of the owner's manual for the product.

We reserve the right to make changes or improvements in our products from time to time without incurring the obligation to install such improvements or changes on equipment or items previously manufactured.

This warranty gives you specific legal rights and you may also have other rights which may vary from state to state.

REMINDER: You must retain the sales slip or sales receipt proving the date of your original purchase in case warranty service is ever required.

LOWRANCE ELECTRONICS
12000 E. SKELLY DRIVE TULSA, OK 74128

(800) 324-1356

NOTICE!

Please check the items in the box against this list. You should have all of the items shown on this page. If you are missing any of the items, please call our special toll-free number:

1-800-324-1353

A RECORDED MESSAGE will request the following information. Please have it ready before you call.

1. Your name, shipping address, and telephone number.
2. The part that's missing.
3. The model, serial number, and DATE AND PLACE OF PURCHASE OF YOUR UNIT.
4. The best time of day to call you if we have questions.

Provided that all of the requested information is recorded and approved by our Customer Service Department, the missing item(s) will be shipped directly to you free of charge.

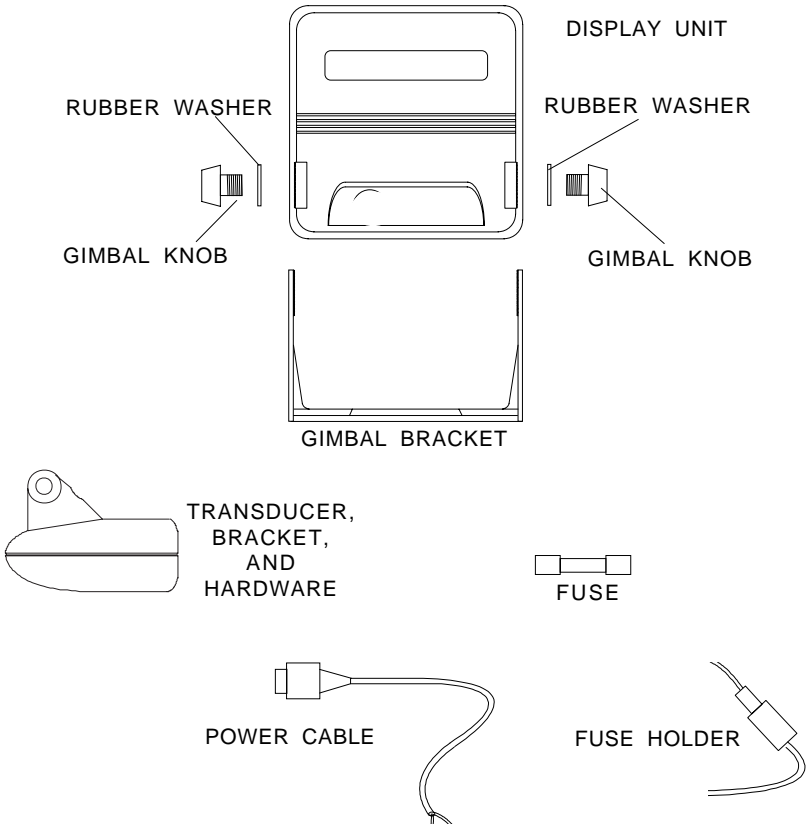

How to Obtain Service (Canadian Customers Only)

We back your investment in quality products with quick, expert service and genuine Lowrance replacement parts. If you need service or repairs, contact the Lowrance Factory Customer Service Department at the toll-free number listed below. A technician may be able to solve the problem and save you the inconvenience of returning your unit. You will be asked for your unit's serial number.

800-324-1356

Canada Only. Monday through Friday 8:00 A.M. - 8:00 P.M. Central Time.

How to Obtain Service (International Customers Only)

If you need service or repairs, contact the dealer in the country you purchased your unit.

**WARRANTY REPAIR WILL BE HONORED ONLY IN THE COUNTRY
UNIT WAS PURCHASED.**

Please follow the shipping instructions shown below on this page if you have to mail your unit to the dealer. For proper testing, repair, and service, send a brief note with the product describing the problem. Be sure to include your name, return shipping address, and a daytime telephone number.

Shipping Information

When sending a product for repair, please do the following:

1. Always use the original shipping container and filler material the product was packed in when shipping your product.
2. Always insure the parcel against damage or loss during shipment. Lowrance does not assume responsibility for goods lost or damaged in transit.
3. For proper testing, repair, and service, send a brief note with the product describing the problem. Be sure to include your name, return shipping address, and a daytime telephone number.

Accessory Ordering Information

To order accessories such as power cables or transducers, please contact:

1. Your local marine dealer. Most quality dealers that handle marine electronic equipment should be able to assist you with these items. Consult your local telephone directory for listings.
2. Canadian customers only can write:
Lowrance/Eagle Canada, 919 Matheson Blvd., E. Mississauga, Ontario L4W2R7
or fax 416-629-3118

How to Obtain Service

We back your investment in quality products with quick, expert service and genuine Lowrance® replacement parts. If you're in the United States and you have questions, please contact the Factory Customer Service Department using our toll-free number listed below. **You must send the unit to the factory for warranty service or repair.** Please call the factory before sending the unit. You will be asked for your unit's serial number. Use the following toll-free number:

800-324-1356

Your unit is covered by a full one-year warranty. (See inside for complete warranty details.) If your unit fails and the failure is not covered by the original warranty, Lowrance has a flat-rate repair policy that covers your unit and accessories packed with the unit at the factory. There is a 180-day warranty on all non-warranty repairs from the factory, which is similar to the original warranty, but is for 180 days rather than one year. For further details, please call us at the above number.

Shipping Information

When sending a product for repair, please do the following:

1. Always use the original shipping container and filler material the product was packed in when shipping your product.
2. Always insure the parcel against damage or loss during shipment. Lowrance does not assume responsibility for goods lost or damaged in transit.
3. For proper testing, repair, and service, send a brief note with the product describing the problem. Be sure to include your name, return shipping address, and a daytime telephone number.

Lowrance Electronics may find it necessary to change or end our shipping policies, regulations, and special offers at any time. We reserve the right to do so without notice.

Accessory Ordering Information

To order accessories such as power cables or transducers, please contact:

- 1) Your local marine dealer. Most quality dealers that handle marine electronic equipment should be able to assist you with these items. Consult your local telephone directory for listings.

- 2) LEI Extras, Inc. P.O. Box 129 Catoosa, OK 74015-0129

or call

800-324-0045

(USA orders only.)

LITHO IN U.S.A.

988-0105-54